

Data sheet | Item number: 2606-1109/020-000

PCB terminal block; lever; 6 mm²; Pin spacing 7.5 mm; 9-pole; Push-in CAGE CLAMP®



2606-1109/020-000



RoHS Compliant

[BOMcheck.net](https://www.bomcheck.net)

Color: ■

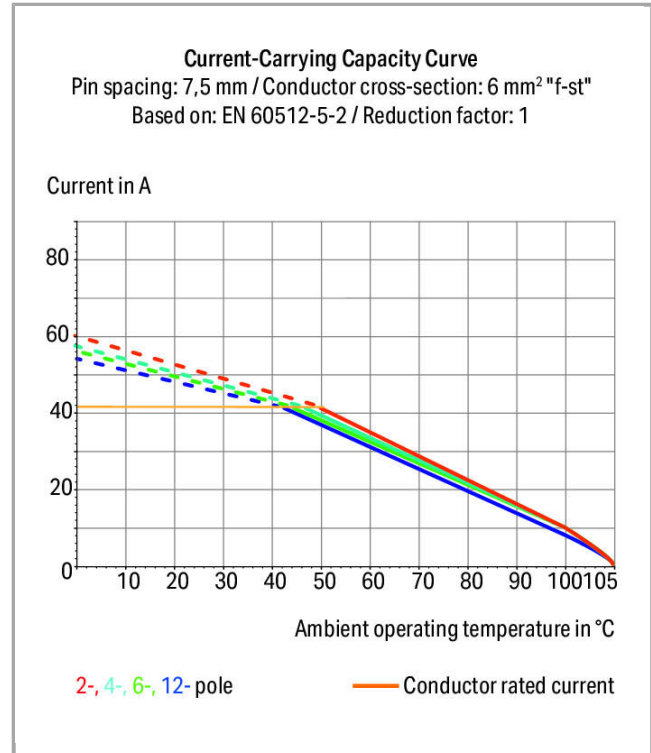

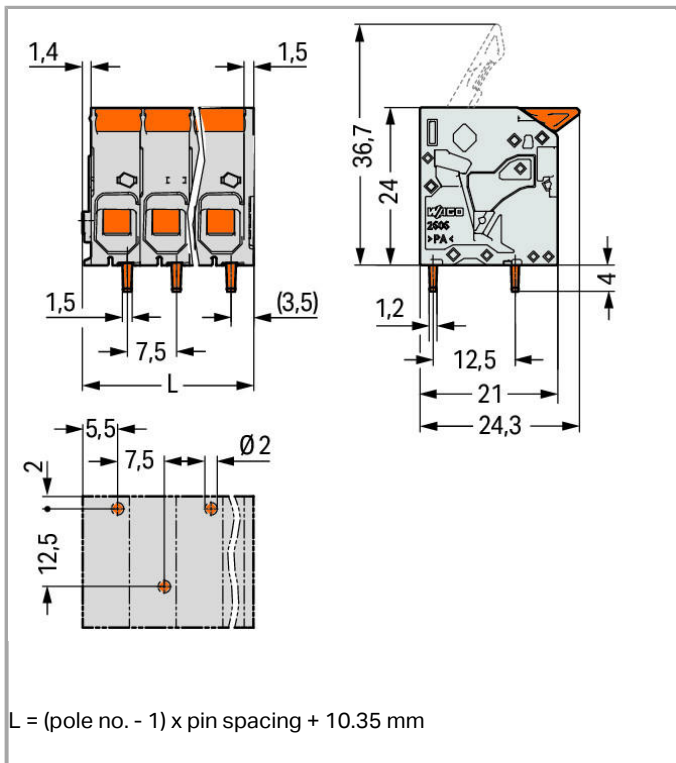

Item description

- PCB terminal blocks with lever-actuated Push-in CAGE CLAMP® connection
- Push-in termination of solid and ferruled conductors
- Intuitive and tool-free operation
- Several clamping units can be held open simultaneously – convenient for terminating multi-core cables
- Testing can be performed both parallel and perpendicular to conductor entry

Data

Electrical data

Ratings per IEC/EN 60664-1

Rated voltage (III / 3)	800 V
Rated impulse voltage (III / 3)	8 kV
Rated voltage (III / 2)	1000 V
Rated impulse voltage (III / 2)	8 kV
Rated voltage (II / 2)	1000 V
Rated impulse voltage (II / 2)	8 kV
Rated current	41 A

Approvals per UL 1059

Rated voltage UL (Use Group B)	600 V
Rated current UL (Use Group B)	31 A
Rated voltage UL (Use Group C)	600 V
Rated current UL (Use Group C)	31 A

Connection data

Connection technology	Push-in CAGE CLAMP®
Actuation type	Lever
Solid conductor	0.2 ... 10 mm ² / 24 ... 8 AWG
Fine-stranded conductor	0.2 ... 10 mm ² / 24 ... 8 AWG
Fine-stranded conductor with ferrule with plastic collar	0.25 ... 6 mm ²
Fine-stranded conductor with ferrule without plastic collar	0.25 ... 6 mm ²
Fine-stranded conductor, with twin ferrule	0.25 ... 2.5 mm ²
Strip length	11 ... 13 mm / 0.43 ... 0.51 inch
Conductor entry angle to the PCB	0°
No. of poles	9
Total number of connection points	9
Total number of potentials	9
Number of connection types	1
Number of levels	1

Geometrical Data

Pin spacing	7.5 mm / 0.295 inch
Width	70.35 mm / 2.77 inch
Height	28 mm / 1.102 inch
Height from the surface	24 mm / 0.945 inch
Depth	24.3 mm / 0.957 inch
Solder pin length	4 mm
Solder pin dimensions	1.5 x 1.2 mm
Drilled hole diameter (tolerance)	2 ^(- ... +0.1) mm

PCB contact

PCB contact	THT
Solder pin arrangement	over the entire terminal strip, staggered
Number of solder pins per potential	1

Material Data

Color	gray
Material group	I
Insulating material	Polyamide 66 (PA 66)
Flammability class per UL94	V0
Clamping spring material	Chrome nickel spring steel (CrNi)
Contact material	Electrolytic copper (E _{Cu})
Contact plating	tin-plated
Fire load	0MJ
Actuating element color	orange
Weight	34.119 g

Environmental Requirements



Limit temperature range	-60 ... +105 °C
-------------------------	-----------------

Commercial data

Country of origin	DE
GTIN	4055143586481
Customs Tariff No.	85369010000

Approvals / Certificates

Country specific Approvals







Logo	Approval	Additional Approval Text	Certificate name
	CB DEKRA Certification B.V.	IEC 60947-7-4	NL 49487 /M1
	CSA DEKRA Certification B.V.	C22.2 No. 158	70146882
	KEMA/KEUR DEKRA Certification B.V.	EN 60947-7-4	71-103042

UL-Approvals

Logo	Approval	Additional Approval Text	Certificate name
	cULus Underwriters Laboratories Inc.	UL 1059	E45172 Sec. 72

Compatible products

ferrule

	Item no.: 216-108 Ferrule; Sleeve for 6 mm ² / AWG 10; uninsulated; electro-tin plated	216-108
	Item no.: 216-208 Ferrule; Sleeve for 6 mm ² / AWG 10; insulated; electro-tin plated; electrolytic copper; gastight crimped; acc. to DIN 46228, Part 4/09.90	216-208
	Item no.: 216-263 Ferrule; Sleeve for 1 mm ² / AWG 18; insulated; electro-tin plated; electrolytic copper; gastight crimped; acc. to DIN 46228, Part 4/09.90	216-263
	Item no.: 216-264 Ferrule; Sleeve for 1.5 mm ² / AWG 16; insulated; electro-tin plated; electrolytic copper; gastight crimped; acc. to DIN 46228, Part 4/09.90	216-264
	Item no.: 216-266 Ferrule; Sleeve for 2.5 mm ² / AWG 14; insulated; electro-tin plated; electrolytic copper; gastight crimped; acc. to DIN 46228, Part 4/09.90	216-266
	Item no.: 216-267 Ferrule; Sleeve for 4 mm ² / AWG 12; insulated; electro-tin plated; electrolytic copper; gastight crimped; acc. to DIN 46228, Part 4/09.90	216-267

Downloads

Documentation

Additional Information

pdf
3.6 MB

[Download](#)

CAD/CAE - Smart Data

CAD data

3D Download 2606-1109/020-000

URL

[Download](#)

Subject to changes.